



Modelling and Optimization of Hybrid Renewable Energy (Solar, Wind and Fuel Cells): A case of South Africa Regions

Sempe Leholo, Pius Adewale Owolawi and
Kayode Timothy Akindeji

EasyChair preprints are intended for rapid
dissemination of research results and are
integrated with the rest of EasyChair.

April 3, 2018

Modelling and Optimization of Hybrid Renewable Energy (Solar, Wind and Fuel Cells): A case of South African Regions

Sempe Thom Leholo*, Pius Adewale Owolawi*, Kayode Timothy Akindeji**

*Department of Computer Systems Engineering, Tshwane University of Technology, Pretoria, South Africa

**Department of Electrical Power Engineering, Durban University of Technology

leholost@tut.ac.za, owolawipa@tut.ac.za and TimothyA@dut.ac.za

Abstract- This paper aims to provide an alternative green energy source for a remote GSM base station. To achieve this, a hybrid renewable energy (RE) plant is proposed, comprising a wind turbine, photovoltaic panels, and a fuel cell (incorporated with electrolyzer and a hydrogen tank for the production and uniform supply of hydrogen). The system will be controlled logically by a power flow controller which will help to provide continuous power to the base station by application of economic optimization of power generation. The hybrid system and the associated load (GSM base station) are simulated using the HOMER software and required analyses carried out. The simulation results show that renewable energy sources are feasible solutions to reducing air contaminants and pollutants (such as SO₂ & CO₂) produced by like diesel generators and also serve as alternate source for remotely located off grid loads.

Keywords: *Renewable Energy, Hybrid system, Optimization, HOMER*

I INTRODUCTION

In the 4th industrial revolution, it is noted that the contributions of information and communication Technology (ICT) and the telecommunication industries play a huge role and hence resulting to a prosperous economic and better life for the people across the globe with special influence on developing countries economy [1]. With regular emerging technologies in the ICT and Telecommunication sectors, it was predicted that by 2018, the mobile telecommunication users will grow to over 6.085 billion mobile users which simply translate to 84% of the world population on the mobile platform. Bearing in mind the statistical estimation and expectation by 2018, the growth in coverage and tele-density will demand more base stations to be planted across the globe with the telecommunication inclusion of rural areas. This will lead to increase in the current emitting statistics for mobile base station that pitched at 1% of the entire world's carbon footprint [2]. In the work by *Feshke et al.* [3] the estimated carbon emission by 2020

will triple the statistic given in 2007, that is the CO₂E will be around 235 Mt by year of 2020.

The introduction of green technologies to power base stations have been extensively investigated by many researchers as presented in references [4,5 and 6].

The demonstration of hybrid RE power system technology needs to be viable commercially with low risk. The designing of a hybrid PV-Wind-Fuel cell power system is the configuration adopted in this paper. Photovoltaic arrays and wind turbine are the two RE sources considered with a complement of fuel-cell. The implementation of the fuel cell technologies consists of process of hydrogen production and storage.

The utilization of solar radiation and wind data with respect to the chosen locations are used in modeling the system. With variations in weather conditions the lack of wind or solar energy sources occurs so the fuel cell serves as the back-up power source. The uniform provision of hydrogen gas will be ensured by using a reformer combined with an electrolyzer considered in the system. Production of hydrogen for a still fuel cell is done when a fixed voltage bus is supplied to direct power by the logic controller then the voltage bus supplies the Base Station(load), when there is excess power generated, then it is directed to the batteries storage first and after to the electrolyzer, that generate hydrogen for the still fuel cell.

The realization of this hybrid system, begins with the first step of optimization model of simulated RE sources using HOMER software. The reformer will not be used in the preliminary simulation because of constraints and limitation that may arise during the first provisional simulation. It must be noted that the only source for the production of hydrogen is the electrolyzer. The results of HOMER's simulation provide information about the economic benefits, optimal status of the best combination of the PV-Wind-Fuel cell. In the following sections are arranged as follows; the RE sources are discussed in section II, section III provides

information on the location and data collection for the project. Section IV gives an overview of the design of the hybrid system integrated with the GSM base station, results are discussed and analysed in section V and conclusion drawn in section VI.

II Renewable Energy Sources Models

A. Wind Turbine (Wind to Energy Conversion Process)

The conversion of wind energy to electricity is achieved by wind turbine as presented in Figure 1. The flowing of wind on the configured wind turbine blades generate a mechanical energy to turn the shaft of the motor, hence produce electricity and the simple mathematical expression for the kinetic energy produced by the turbine is given by [7]:

$$P_{KE} = \frac{1}{2} \times \rho_{air} \times A \times S_{wind}^3 \quad (1)$$

where A is the transversed area by the winds and measure in meter square (m^2), ρ_{air} is observed to be the air density and the S_{wind} is the wind speed measure in (m/s). The generated electric power by the wind turbine is expressed as as:

$$P_w = \frac{1}{2} \times \rho_{air} \times C_e \times A \times S_{wind}^3 \times 10^{-3} \quad (2)$$

where C_e is the coefficient of the wind turbine performance as a function of the rotor blade speed ratio and pitch angle of the blade and often available from the manufacture datasheet.

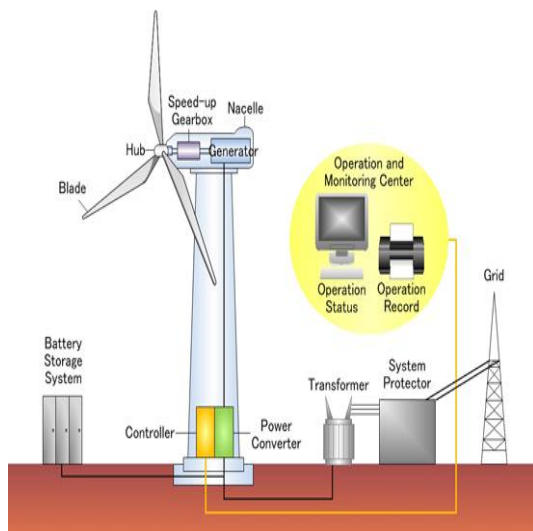

Fig. 1. Block diagram of wind turbine operation [8]

The implementation of the systems simply convert the AC supply from the wind turbine through the AC bus and the AC/DC converter is further used to generate equivalent DC which is loaded on the DC bus.

B. Photovoltaic System Architecture

Actual AC power from a photovoltaic system can be obtained by the conversion of output DC power into the required AC power by an array of photovoltaic modules connected together and a DC/AC converter. The estimated output from the conversion of a single module can be determined with the expression in equation (3) as presented:

$$P_{ac} = P_{DC(STC)} \times \eta \quad (4)$$

where P_{ac} is the actual AC power obtained, P_{DC} is the standard test conditions rated DC power and η is the DC/AC converter conversion efficiency. The energy produced from the PV systems is given in equation (5) as [9]:

$$P_{PV} = A_{PV} \times \eta_{mo} \times p_f \times p_{pe} \times I_h \quad (5)$$

where A_{PV} is the total area of the PV coverage and its measure in meter square m^2 , η_{mo} is the module efficiency, p_f packing factor, p_{pe} is the power condition of efficiency and I_h is the hourly irradiance.

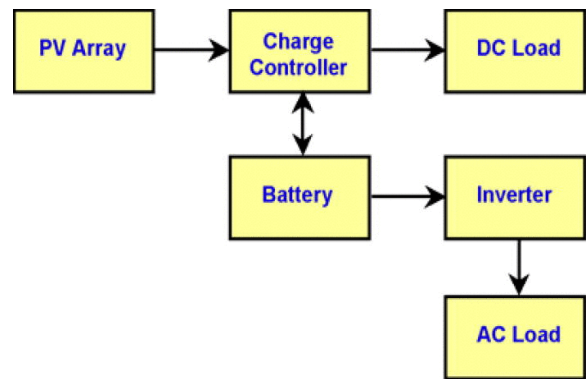

Fig. 2. Block diagram of solar system [10]

C. Fuel Cell design and configuration

The conversion of chemical energy to electrical energy is achieved by using fuel cell systems. This is done by converting hydrogen into electrical energy. The efficiency of the conversion of the chemical energy through the hydrogen conversion into electricity is around 60% as when compared with the thermal power plant which has a record of maximum efficiency of 40%. The incorporated fuel cell is included to provide a back up when wind and PV failed.

The chemistry of the operation of fuel cell is based on oxidation processes. In proton Exchange Membrane while the fuel cell is operating at 25°C and with a 50 mA/cm^2 current density, providing a terminal voltage of 0.92 V, assuming 95% of the H_2 is consumed at the anode electrode, with the efficiency at 60%.

In this hybrid system, the fuel cell will be operating as back-up when the two renewable energy sources do not supply the required power and when the batteries storage is discharged to a level that can't supply enough power to the

load. The general efficiency of power generated by the fuel cell can be estimated is expressed by equation (6) [11]:

$$\eta_{Fuel_cell} = \eta_t \times \eta_e \times \eta_r \quad (6)$$

Where η_t is the thermal efficiency, η_e is the electrical efficiency and η_r is the reaction efficiency. A process of decomposition of water into its elementary components is done by the passing electric current through it. With the utilization of Faraday's law, estimation of an electrolyzer's hydrogen production can be determined using the expression in equation (7) :

$$\eta_{H_2} = 0.5\eta_f \times \eta_c \times \frac{i_e}{F} \quad (7)$$

where η_{H_2} is hydrogen produced, η_f faraday efficiency, η_c is the number of electrolyzer cells in series, F is the faraday constant and i_e is the current of the electrolyzer.

Hydrogen and oxygen from the air are passed through the Proton exchange membrane fuel cells to release water, electricity and heat. The catalyst layers that contains Anode and cathode are situated in the membrane in the middle of the cell. The separation of hydrogen molecules into protons and electrons takes place at the anode catalyst layer. Transfer of protons is permitted by the membrane, flow of electrons through an external circuit is enabled before their recombination with oxygen and protons at the cathode for the formation of water. Production of electricity happens when migration of electrons takes place. The reactions fuel cells anode and cathode are shown below:

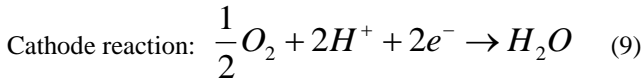
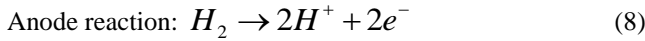

III LOCATION AND DATA COLLECTION

A. Location of interest

The abundant of natural energy sources in the Southern Africa located at latitude and longitude 25.0 degree East and 30.00 degree South respectively [12,13]. Since the amount of sun, radiance and wind speed are location based, the site of interest for this work is Durban (29.87S, 31.00E) in KwaZulu-Natal province. For the best accuracy, ground-based solar radiometric data with the high-resolution available from stations located across South Africa under the custodian of Southern African Universities Radiometric Networks (SAURAN) [14].

B. Characterisation of the chosen site

Figure 3 presents the wind speed, clearnes index and solar irradiance. The clearness index is a parmeter used to measure the degree of clearness of the atmosphere which is defined as

the ratio of surface radiation to the extraterrestrial radiation. It is a deimesionless quantity and range between o to 1. The clearness index has a high value under clear, sunny conditions, and a low value under cloudy conditions.

In the case of the chosen site, the maximum wind speed, clearness index, and solar irradiance are 4.1 m/s, 0.91 and 8.45 KWh/ m^2 /day respectively. While in the case of the minimum wind speed, clearness index, and solar irradiance are 3.1 m/s, 0.35 and 3.42 kWh/ m^2 /day respectively.

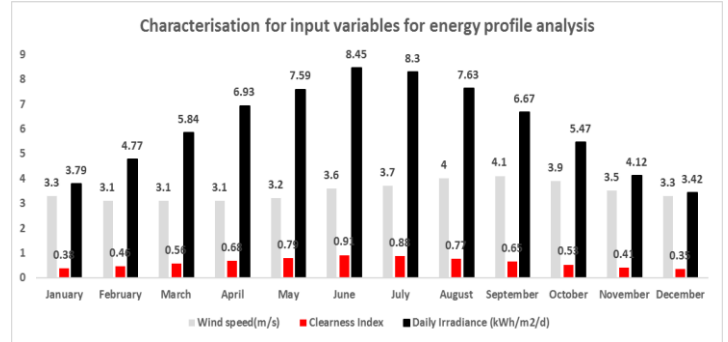

Fig. 3. Charcterization of wind speed clearness index and daily irradiance

IV DESIGN OF HYBRID SYSTEMS WITH BASE STATION

A. Systems configuration

The AC and DC buses are linked together by a converter and the photovoltaic along with the battery modules are connected to the DC bus, while the turbine system is connected to the AC bus directly supplying power to the load. Parallel modelling of the hybrid system was utilized as this configuration allows for a bi-directional synchronous power flow between the renewable energy sources and the battery bank, this configuration produces great efficiency by eliminating risk of minimum power supply breaks [15].

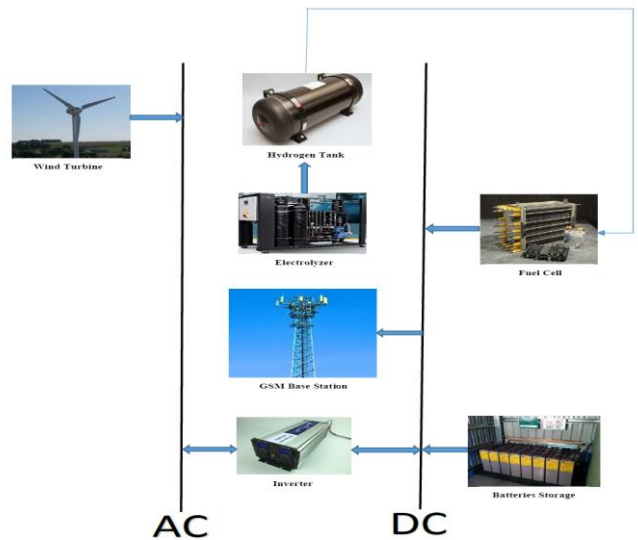

Fig. 4. Block diagram Hybrid System Design.

In the instance when the BTS demand is less than energy production that of the solar and wind, the excess electricity supply is stored into the battery storage bank while the excess energy generated after been stored in the battery bank is utilized to cover the deficit when the load demands more energy than what the hybrid energy system generates at that moment [15]. Table 1 presents the cost of the equipment and other resources used to implement the configuration in Figure 4.

TABLE 1: QUANTITY OF UTILIZED EQUIPMENT FOR THE PROJECT

Number	Component	Description	Quantity
1	Solar Panel	Poly 315W Solar Panel (SW315P-72)	129 pieces
2	10KW grid tied Inverter	AC220/240V,50/60HZ	1 set
3	AGM Battery	12V 250AH	12 pieces
4	Mounting Support	Pitched/flat roof , Ground	1 set
5	PV Cable	Single-core 4mm ² and 10mm ²	2k meters
6	Connector	MC4 Connector	40 pairs
7	Tools bag	5 Kind of PV installation tools	1 bag
8	Fuel Cell	ALFA MOLA-G10	1 set
9	Electrolyzer	HENGYUAN10kw	1 set
10	Hydrogen tank	LIXI CNG-2-325-80	1 set

B. Systems simulation

The HOMER Ssoftware is utilised to simulate the system configuration shown in Figure 4. The average power demand of a base station (BTS) is approximately 117 kWh/day is considered in this work. In this study, peak demands of almost 7.5 kW for the load are modeled with a load factor of 0.65; i.e., In Oder to get the load factor we look at the total electricity (KWh) consumed in a day then divide it by the peak power demand (KW), then we divide it by the number of days in the billing cycle, which is then divided by 24 hours in a day. Figure 5 presents load profile for a GSM base station and this is used to simulate the system configuration presented in Figure 4.

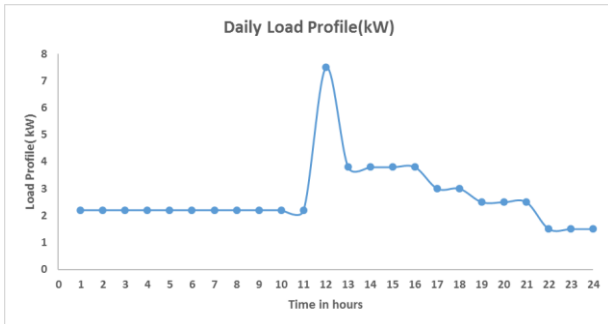

Fig. 5. Daily power profile for a base station.

C. Systems Cost

The capital cost, replacement cost and O&M of the configured systems is presented in Table 2. The main components introduced are solar panel, inverter, AGM battery, fuel cell, electrolyzer and hydrogen tank.

TABLE 2: COST OF UTILIZED EQUIPMENT FOR THE PROJECT

Component	Capital Cost	Replacement cost	O&M
Solar Panel	R100000/40kw	R100 000.00	31 R/y
Inverter	R10 000/10kw	R9 375.00	0 R/y
AGM Battery	R60000/50kw	R52 000.00	15 R/y
Fuel Cell	R38 000/5kw	R34 000.00	0.975 R/h/kw
Electrolyzer	R18 000/10kw	R15 000.00	150 R/y
Hydrogen tank	R3500/5kg	R2800.00	0y

V RESULT AND ANALYSIS OF SIMULATION

A. Total electricity production

The annual electricity produced by the three energy sources as presented in Figure 6, PV, Wind turbine and fuel cell summed up to 103488 kWh/year where the PV contributes 66%, followed by wind turbine with 33% and least is fuel cell with 1%.

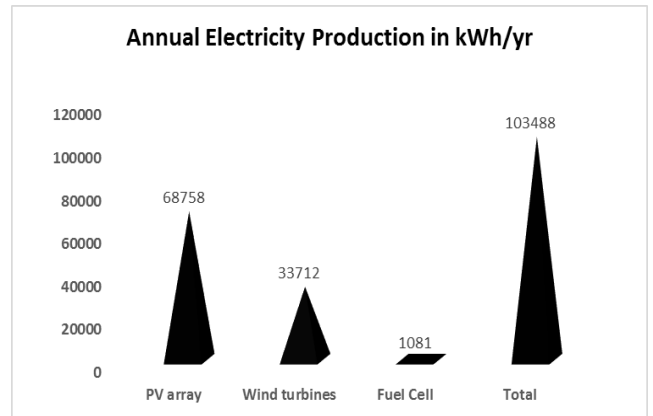

Fig. 6. Annual Electricity Production in kWh/yr.

The contribution of the green energy sources is to mitigate against carbo emission. The pollutants are carbon dioxide, carbon monoxide, unburned hydrocarbons, particle matter, sulfur dioxide and Nitrogen oxides which have emission rate measured in Kg/yr as -3.68, 2.34, 0.259, 0.176, 0 and 20.9 respectively. It is noted that Sulfur dioxide recorded 0 kg/yr.

B. Economic Analysis

In this work, a lifetime of 20 years is adopted for the project. The annual cost is calculated by multiplying the initial cost by the capital recovery factor (CRF), hence the expression in equation (8)[16]:

$$CRF = \left[i_r (1 + i_r)^{ny} \right] / \left[(1 + i_r)^{ny} - 1 \right] \quad (10)$$

where:

i_r = interest rate annually

ny = component life time.

In the case of the electrolyzer and the Fuel Cell, replacement of stacks will be available and after certain span of time there would be replacement of some of the batteries. However, PV and wind can work for the whole lifespan of the project. In this instance, the fuel cell, electrolyzer, battery annual capital cost can be calculated through the formula:

$$ACC = C_{fix1} * CRF_1 + C_{rep} * CRF_2 + C_{fix2} * CRF_{battery} \quad (11)$$

where:

$C_{fix1\&2}$ = individual component initial cost

$C_{rep} = C_{cell} * N_{cell}$ = fuel cell and electrolyzer replacement cost

$CRF_{1\&2}$ = capital recovery factor

Calculation of the cost of Electricity (COE) can be done by the addition of the overall annual operation and maintenance cost (ACC_{total}) and the total annual cost of individual component (AMC_{total}) after we multiply it with the annual inverse Energy Demand (AED) as shown below [16].

$$COE = \frac{(ACC_{total} + AMC_{total})}{AED} \quad (12)$$

Below is the cost breakdown of the hybrid system result obtained through HOMER Simulation for our selected load center of 117 kwh/day. For this analysis the levelized cost of energy is uneconomical estimated to be 14.8096 R/kWh when compared to the current average electricity charge of 0.074 R/kWh. For the electrolyzer/Fuel cell system the cost of energy is calculated as 2.102 R/KWh and for the battery storage system 0.00385 R/kWh [3]. Environmental benefits of the proposed hybrid generation system are considered it generation system are clear by the emissions results this cost will be far less reduce the harm to the environment.

VI CONCLUSION

From the results obtained through HOMER optimization simulation it's clear that this system can be considered for implementation. There is a capacity shortage of 5578 kWh annually with an excess load of only 42,306 kWh per year. The solar power is the major power production out of the 100% production taking 66% while wind turbine has an annual estimate of 33% respectively. The fuel cell produces only 1% in the system, it is meant only for back-up power

because only a 5kW fuel cell was considered for the system. It's clear that the system is environmental friendly when looking at the annual emission results we got from HOMER software. Detailed economic analysis in future is required for practical implementation as the consideration of equipment's was done optimistically for the GSM Base Station.

REFERENCES

- [1] Sara Radicati, PhD Mobile Statistics Report, 2014-2018 THE RADICATI GROUP, INC. A TECHNOLOGY MARKET RESEARCH FIRM PALO ALTO, CA, USA 2014
- [2] C. Lamour, "Energy Consumption of Mobile Networks," in the Basestation e-Newsletter, 2008.
- [3] Cisco visual networking index forecast projects nearly 11-fold increase in global mobile data traffic from 2013 to 2018; Cisco Public: San Francisco, CA, US, 2014.
- [4] A. Anayochukwu and E. Nnene, "Simulation and Optimization of Hybrid Diesel Power Generation System for GSM Base Station Site in Nigeria", *Electronic Journal of Energy & Environment*, vol. 1, no. 1, 2013.
- [5] Asif, R. and Khanzada, F. (2015). Cellular Base Station Powered by Hybrid Energy Options. *International Journal of Computer Applications*, 115(22), pp.35-39.
- [6] J Wu, Y Zhang, and M Zukerman (2018) A Survey on Energy Efficient Base Station Sleeping Techniques in Green Communications. *International Journal of Recent Trends in Engineering and Research*, pp.126-133.
- [7] NREL. Wind turbine calculator. Available from: www.nrel.gov/analysis/Power_databook/calc_wind.php; 2005 [accessed 24.03.12].
- [8] Pena R., Clare J.C., Asher G.M., May 1996. "Doubly fed induction generator using back-to-back PWM converters and its application to variable-speed wind-energy generation". *IEEE Proc. - Electr. Power Appl.* Vol. 143, No.3.
- [9] G. M. Master, Renewable and efficient electric power systems. (2005). *Choice Reviews Online*, 42(06), pp.42-3448-42-3448.
- [10] O. Asowata, J. Swart and C. Pienaar, "Evaluating the effect of orientation angles on the output power of a stationary photovoltaic panel", *Journal of Renewable and Sustainable Energy*, vol. 6, no. 4, p. 043114, 2014.
- [11] Fuel cell power systems, DC voltage converters, power generation and power conditioning Applicant: Avista Labs, USA Patent number: WO 01/78176
- [12] South Africa—An Overview. <https://www.mbandi.com/land/af/sa/p0005.html>
- [13] P.Noris "Weather Satellite – Forecasting the weather" Watching Earth from space. Springer Praxis books 2011
- [14] <http://www.sauran.net> [accessed 04.02.18]
- [15] K. Kusakana and H. Vermaak, "Hybrid renewable power systems for mobile telephony base stations in developing countries", *Renewable Energy*, vol. 51, pp. 419-425, 2013.
- [16] D. B. Nelson, M. H. Nehrir and C. Wang, "Unit sizing of stand-alone hybrid wind/PV/fuel cell power generation systems," *IEEE Power Engineering Society General Meeting*, 2005, 2005, pp. 2116-2122 Vol. 3. doi: 10.1109/PES.2005.1489286